

INSTALLATION, OPERATION AND MAINTENANCE MANUAL

Ecomag

Linear actuator

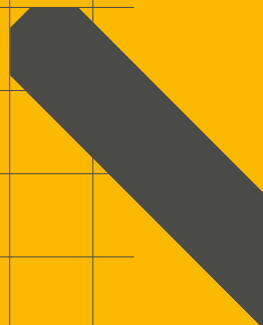

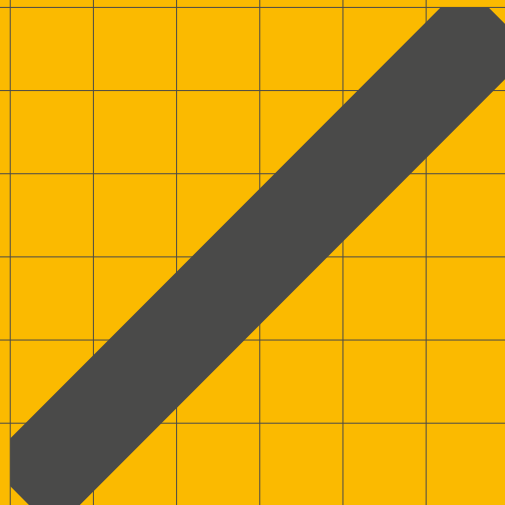
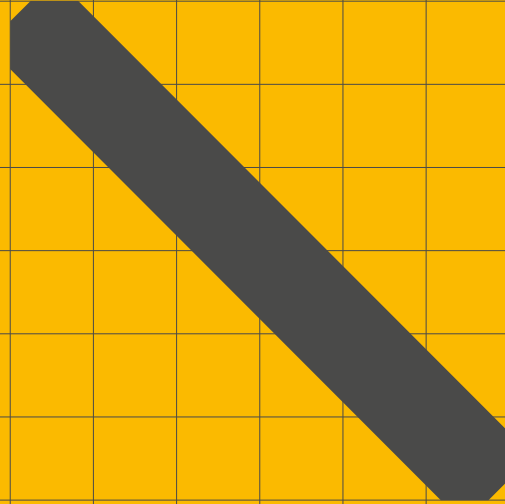

Contents

1.0 Important safety information	4	6.0 Maintenance and Care	13
2.0 General.....	5	6.1 5.1 Maintenance	13
2.1 Using the Technical Instructions	5	6.1.1 Duty cycle	13
2.2 Correct usage	5	6.1.2 Thermofuse	13
2.3 Ambient conditions	5	6.2 Care.....	13
3.0 Function	6	6.2.1 Protection from water, cleaning, disinfecting	13
4.0 Installation and startup.....	7	6.3 Disposal	13
4.1 Scope of delivery.....	7	6.4 Liability	14
4.2 Installation.....	7	6.5 Troubleshooting	15
4.2.1 Mounting position	7	7.0 Appendix	16
4.2.2 Mounting the control unit on the actuator (ECO 2/3/6/7 only).....	7		
4.2.3 Removing the control unit.....	7		
4.2.4 Fastening the control unit externally	8		
4.2.5 Installing / uninstalling the earth cable (option).....	8		
4.3 Startup.....	8		
4.3.1 Opening the control box cover	8		
4.3.2 Connecting / disconnecting the actuator cable on the control unit.....	8		
4.3.3 Connecting / disconnecting the control device	9		
4.3.4 Closing the control box cover.....	9		
5.0 Operation	10		
5.1 Controlling an actuator.....	10		
5.1.1 Fastening hook.....	10		
5.2 Locking device	10		
5.2.1 Locking the handswitch.....	10		
5.2.2 Unlocking the handswitch	10		
5.3 "Emergency lowering" in the event of a power failure (option)	11		
5.3.1 Changing the batteries	11		
5.4 Rapid adjustment (optional).....	11		
5.4.1 Function	11		
5.4.2 Usage	12		

WARNING

Read this manual before installing, operating or maintaining this actuator. Failure to follow safety precautions and instructions could cause actuator failure and result in serious injury, death or property damage.

1.0 Important safety information

The actuator is assembled and delivered by Ewellix according to the ordering key. Modification of the actuator is not allowed in any way. Any modification will void the warranty and could create a safety hazard. Ewellix disclaims any and all liability or responsibility for the modified product and for any claims, demands or causes of action for damage or for personal injury resulting from modification and/or use of such product. In addition, if the actuator has been disassembled, misused or altered without prior written authorisation, warranty will be voided. These installation instructions are part of the actuator and should be kept together with all relevant documentation regarding the application in which it is used.

The following are important safety precautions that must be followed during installation:

- All electrical installation and maintenance should be carried out by qualified personnel.
- Terminate power supply to the actuator before installation or maintenance.
- Make sure that the actuator is not under load or in tension before installation or maintenance.
- Use the appropriate safety equipment when installing/repairing the actuator.
- When connecting the actuator, make sure that the power supply corresponds to what is required in the technical specifications. See section 5 below.
- When heavy load and high duty factor is used, motor and surrounding components can get hot.

DANGER

Indicates a dangerous situation, which will lead to death or serious personal injury, if the precautionary measures are ignored.

WARNING

Indicates a dangerous situation, which can lead to minor or moderate injury or property damage, if the precautionary measures are ignored.

CAUTION

Indicates a dangerous situation, which can lead to minor or moderate injury if the precautionary measures are ignored.

NOTICE

Indicates information considered important, but not hazard-related (e.g. messages relating to property damage).



NOTE

Emphasizes useful hints and recommendations as well as information for efficient and trouble-free operation.

2.0 General

2.1 Using the Technical Instructions

The Technical Instructions are intended for designers or specialists who use the ECOMAG linear actuator in their products, and for fitters who work with the actuator. The Technical Instructions contain all relevant information on this Ewellix product.

We reserve the right to make changes which are in the interest of technical progress.

Please read the Technical Instructions carefully and, above all, pay careful attention to the Safety Instructions.

The Technical Instructions should be used for drawing up the User Manual for the end product.

2.2 Correct usage

The ECOMAG linear actuator has been designed for use in conjunction with the following Ewellix components:

- SEM 1 control unit and
 - EHE handswitch
- and is specifically intended for adjusting chairs and couches in medical and care sectors.

Other uses must be discussed with Ewellix Liestal.

2.3 Ambient conditions

Operation:

Temperature 10 °C to 40 °C

Humidity max. 85%

WARNING

This actuator must not be operated in potentially explosive atmospheres.

Storage / transport:

Temperature -20 °C to 60 °C

Humidity max. 95%

The unit is only suitable for indoor use and must not be subjected to the elements.

3.0 Function

ECOMAG linear actuators are DC actuators with worm gears and spindle units. The gears convert the motor's rotational movement into a linear movement through the threaded spindle's rotation being transferred to a pushing tube via a special nut.

The stroke is limited by built-in limit switches.

The power is supplied via an attachable or externally fitted SEM 1 control unit. The control unit consists of a control box housing the transformer, the converter, up to 4 motor socket connections and a socket connection for the control device (e.g. handswitch).

⚠ WARNING

The maximum load specified on the label must not be exceeded, since doing so will mean that the prescribed level of safety will not be provided.
The actuator may be destroyed if it is overloaded!

The linear actuator is operated using a control device (e.g. an EHE handswitch).

The feed speed is a function of the load!

The ECOMAG can be loaded with push forces (ECO 2/4/6/8) or pull and push forces (ECO 3/5/7/9).

⚠ DANGER

The ECOMAG linear actuator "push version" (ECO 2/4/6/8) may only be subjected to compressive loads. If pull forces are applied, the push tube can disengage from the outer tube.
Risk of accident!

The maximum load on the actuator shown on the label refers to the centric push tube axis.

A mechanical anti-pinching device for pull forces is fitted in the "push" versions. In the "pull-push" versions, a mechanical anti-pinching device is available as an option.

The self locking of the actuator is at least equal to the push-/pullforce.

4.0 Installation and startup

4.1 Scope of delivery

The ECOMAG actuator system comprises the following:

- Control unit
- Actuator and
- Control device

4.2 Installation

The linear actuator must only be installed over the two fork heads. The load must act centrally on the push tube axis and, when the actuator is installed, it must be free from any other mechanical forces.

⚠ DANGER

The bolts and brackets for transferring the forces must be suitable for the purpose intended and be matched to the dimensions of the fastening fittings.

Risk of accident!

If there is a risk of hitting a mechanical limit stop during a stroke movement, Ewellix recommends that mechanical anti-pinching protection or a current cutoff device be used.

When the rapid adjustment option is used, it must be ensured that the entire stroke movement can be completed.

4.2.1 Mounting position

As a general rule, all mounting positions are possible, provided the following points are noted:

If the control unit is plugged in, only the mounting positions shown in **Fig. 1** from 0° to 90° are permitted.

If an overhang arrangement is used, the control unit must also be fixed in position with cable ties. The control unit can otherwise work itself loose.

Fig. 1

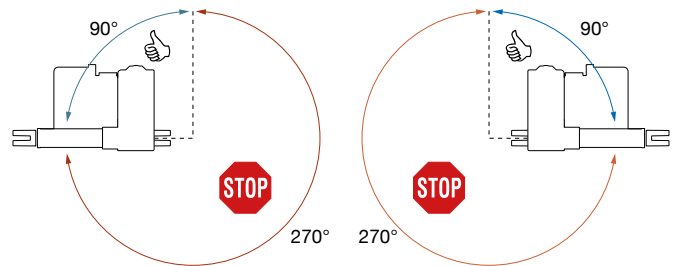

4.2.2 Mounting the control unit on the actuator (ECO 2/3/6/7 only)

Slide the control unit onto the actuator as shown in **fig. 2**.

The control unit locks into position with an audible click of the locking mechanism.

Fig. 2

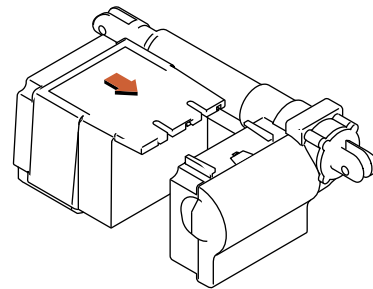

4.2.3 Removing the control unit

Gently lift the nose with a screwdriver, and at the same time push the control box in the direction of the arrow (→ **Fig. 3**).

Fig. 3

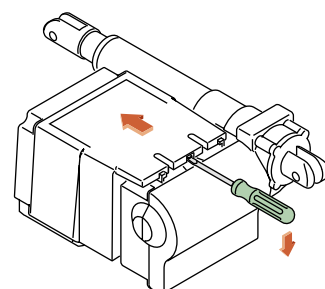

4.2.4 Fastening the control unit externally

The control unit must be installed at the installation slots provided (↳ Fig. 4), and must be installed so that it is free from mechanical forces and vibrations.

Tightening torque: 1.7 – 2 Nm

Fig. 4

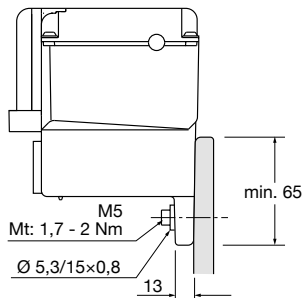

4.2.5 Installing / uninstalling the earth cable (option)

- Undo the nut (4) and contact washer (3) from the grounding bolt (1). (↳ fig. 5)
- Push the cable lug for M4 (2) of the device you wish to earth over the grounding bolt (1).
- Fasten the grounding bolt (1) onto the hexagon using the wrench (5).
- Screw the contact washer (3) and nut (4) onto the thread of the grounding bolt (1).
- Tighten with the torque wrench to 1.5 Nm – 1.8 Nm.

The cable is uninstalled in the reverse order.

Fig. 5

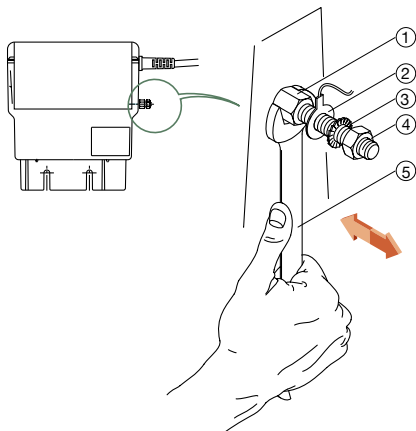

⚠ DANGER

To ensure that the grounding bolt (1) does not rotate too, it must be fixed in position using a wrench (5) when the device's earth connection is being tightened or unscrewed. Risk of accident!

4.3 Startup

4.3.1 Opening the control box cover

Gently lift the nose with a screwdriver, and at the same time push the control box cover in the direction of the arrow (↳ Fig. 6).

Fig. 6

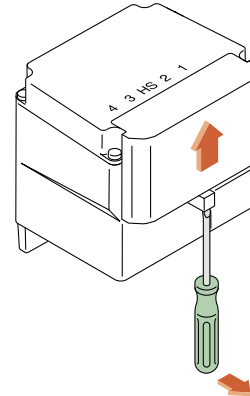

⚠ WARNING

All cables must be secured so that no forces act on the control unit connections. Incorrectly connected cables may become loose and damage the control unit!

4.3.2 Connecting / disconnecting the actuator cable on the control unit

- Connect the actuator cable in the direction of the arrow (↳ Fig. 7). **Note:** Observe the plug number.
- Disconnect the actuator cable in the direction of the arrow (↳ Fig. 8).

Fig. 7

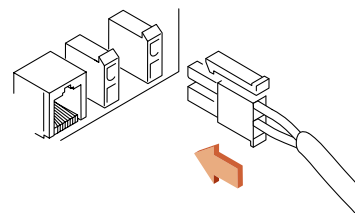
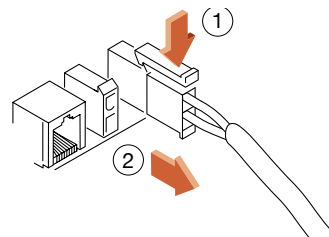

Fig. 8



⚠ WARNING

Motor connections that are not occupied on the control unit are sealed at the factory. The seals must not be removed. If liquid is allowed to penetrate the seals, the control unit will be damaged!

4.3.3 Connecting / disconnecting the control device

- Connect the control device plug (e.g. handswitch) in the direction of the arrow (↳ **fig. 9**). **Note:** Observe the plug type.
- Disconnect the plug in the direction of the arrow (↳ **Fig. 10**).

Fig. 9

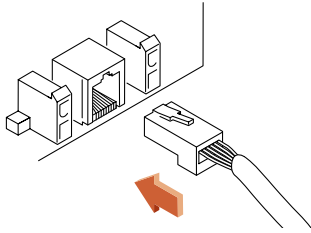
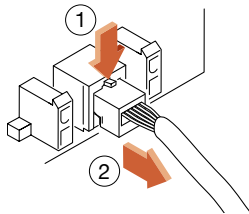

Fig. 10



⚠ WARNING

You should ensure that the handswitch cable plug is inserted correctly.
If the front film is damaged (i.e. allowing liquid to penetrate), the handswitch must be replaced. The handswitch would be damaged if liquid were allowed to penetrate it!

4.3.4 Closing the control box cover

- Move the control box cover in the direction of the arrow (↳ **Fig. 11**).
- The control box cover is only closed once an audible click of the locking mechanism is heard.

Fig. 11

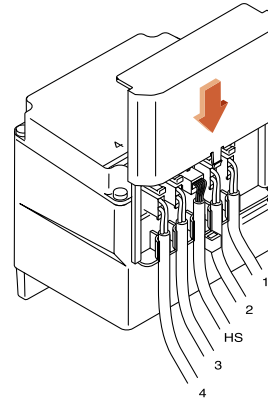

⚠ WARNING

Protection class IPX4 is only guaranteed if the control box cover is closed with an audible click of the locking mechanism, and the seal edges and nose are not damaged

5.0 Operation

5.1 Controlling an actuator

The EHE handswitch is used to actuate one or more ECOMAG linear actuators. A control panel is provided on the front foil of each handswitch for each actuator that is to be controlled (→ **fig. 12**). This consists of two push-buttons that are positioned offset from each other. On the front plate are the symbols which are assigned to the function and are used for adjusting the individual linear actuators.

Up to 4 linear actuators can be actuated separately.

Fig. 12

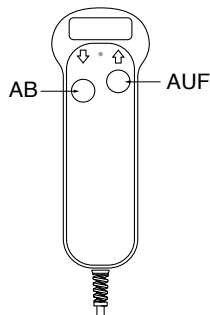

⚠ DANGER

If the feed speed of the linear actuator diminishes, or it no longer works under load, it must be uninstalled immediately and taken out of use.
Risk of personal injury!

Pressing one of the push-buttons activates the relevant linear actuator. It moves for as long as the button is held depressed.

- Button The actuator extends
- Button The actuator retracts

5.1.1 Fastening hook

It is possible to retrofit the handswitch with a fastening hook.

The fastening hook is attached to the adhesive surface provided on the rear of the handswitch using adhesive film.

5.2 Locking device

As an option, it is also possible to lock the individual actuators on the EHE handswitch. This gives the unit failure safety in accordance with EN 60601-2-38.

In Lock or Unlock programming mode, the locking key must always be placed in the bores situated on the rear of the handswitch.

Fig. 13

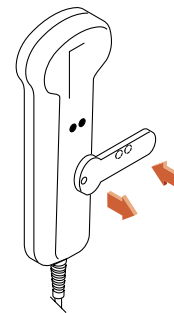

⚠ WARNING

To avoid inadvertent activation of the control device, we recommend the optional locking device (EHE3).

Note

After locking or unlocking, the locking key must be removed and the set functions checked.

5.2.1 Locking the handswitch

Place the locking key with cam into the bore on the rear of the handswitch.

Press the "DOWN" button of the actuator that is to be locked. The display lights up yellow. The actuator is locked.

5.2.2 Unlocking the handswitch

Place the locking key with cam into the bore on the rear of the handswitch.

Press the "UP" button of the locked actuator. The display lights up green. The actuator is unlocked.

5.3 "Emergency lowering" in the event of a power failure (option)

If the power fails, the actuators can be moved to their lower terminal position.

If the "EMERGENCY lowering" features a patient safety function in the event of a power failure, the user must ensure that:

- the battery capacity is satisfactory,
- the function is checked regularly by briefly pressing the "AB" ("DOWN") button.

The following batteries, which have been approved by the manufacturer, may be used:

- Panasonic 9 V Alkaline 6LR61,
- Varta 9 V Alkaline 6LR61 and
- Energizer 9 V Alkaline 6LR61

5.3.1 Changing the batteries

- Remove the cover (↳ Fig. 14).
- Replace the batteries.
- Replace the cover with the line mark facing upwards.

Fig. 14

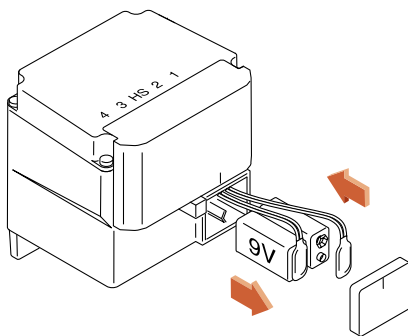

⚠ WARNING

Ewellix, recommends that the batteries be replaced each time the "EMERGENCY lowering" function is used. Damaged, spent batteries must be replaced anyway.

⚠ WARNING

Batteries must be disposed of correctly or returned to Ewellix. They must not be disposed of in the general household waste!

⚠ WARNING

Protection class IPX4 is only guaranteed if the marking on the cover matches the marking on the housing.

5.4 Rapid adjustment (optional)

5.4.1 Function

The rapid adjustment function is used for "emergency rapid lowering" of the head or the foot of the bed (during patient resuscitation).

If a power failure or actuator malfunction should occur, or for beds which are not connected to a power supply, the rapid adjustment device can be used to manually lower the head or foot of the bed (further option).

When installing an actuator with rapid adjustment function, a warning notice (↳ Fig. 15) in accordance with EN 60601-1, Section 6.3c and 6.4, must be attached clearly to the end product (insofar as the end application is subject to this standard).

Fig. 15

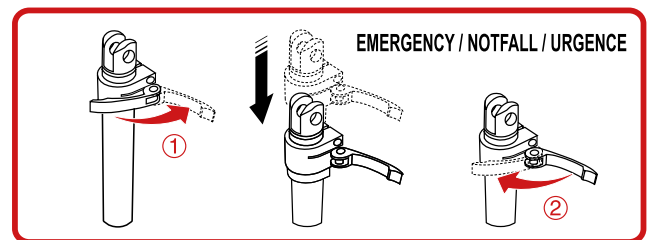

⚠ WARNING

The rapid adjustment function should only be used in emergencies, or to test that it is working properly.

When retracted, the actuator must lie against a fixed limit stop (e.g. bed frame), since otherwise the actuator may be damaged by a rapid- lowering action.

No transverse forces (misaligned mounting) must be allowed to act on the linear actuator, since otherwise the function of the rapid adjustment feature cannot be guaranteed.

The screws in the pivot clamp must not be tightened or loosened!

⚠ WARNING

The rapid adjustment function must be checked every 6 months.

5.4.2 Usage

- Open the red clamping lever (↳ **Fig. 16, (1)**).
While doing so, hold the head of the bed firmly. Depending on the bed design, the head or foot can lower quickly.

Fig. 16



- Manually press the rapid adjustment mechanism downwards (↳ **Fig. 17, (3)** e.g. backrest).

Fig. 17



- Close the red clamping lever (↳ **Fig. 18, (1)**) until it reaches its end position (4).

Fig. 18



You must ensure that, whatever position the clamping lever is in, it can be actuated as shown in **figs. 14 and 15**.

After a rapid lowering action, the clamping lever must be in closed position before the linear actuator is used again.

6.0 Maintenance and Care

6.1 5.1 Maintenance

The actuators may only be opened and worked on by the Ewellix Customer Service.

The fork heads, housing and power cable must be checked for mechanical damage (e.g. cracks) every 6 months.

DANGER

The maximum current consumption under full load must be measured. It must not exceed the value specified on the label. Higher current consumption means that the linear actuator is overloaded and may be damaged!

The user must undertake to monitor the products vigilantly.

The actuators are greased with Ewellix-approved lubricants, and do not require any maintenance for the following service life:

Service life: Max. 10 000 double-strokes with a stroke of 200 mm.

(The question of how the double-stroke specification is translated into a useful service life must be defined by the manufacturer of the end product).

When the service life expires, the actuator must be removed and overhauled by the manufacturer. Risk of personal injury!

For applications where it is highly likely that the service life will be exceeded, we recommend the use of the optional safety nut.

The rapid adjustment option must be checked every 6 months. If excessive force is needed to move the actuator, or it runs too freely, it should be exchanged.

6.1.1 Duty cycle

The actuator has been designed for intermittent operation (see label). If a higher duty cycle is used, please contact the Ewellix factory.

6.1.2 Thermofuse

The ECOMAG linear actuator is fitted with a thermofuse. The thermostwitch integrated into the motor switches the actuator off if the temperature becomes excessive.

6.2 Care

6.2.1 Protection from water, cleaning, disinfecting

The following protection classes are only guaranteed in assembled status:

- Linear actuator and control unit IP X4
- Housing of the optional mains disconnection device IP X0
- Handswitch IP X6 and IP X7

Clean after use in order to avoid the accretion of residues!

The actuator may be cleaned with a damp cloth and water. Add a little isopropyl alcohol if necessary

WARNING

Ensure that no liquids are allowed to penetrate the connections!

WARNING

Washing water with chemical additives must be pH neutral. Excessively acidic or alkaline washing water can permanently damage the metal and plastic components of the actuator. High-pressure steam cleansing equipment must not be used.

6.3 Disposal

The actuators and control unit components may be returned to Ewellix for disposal.

6.4 Liability

In every case, the owner or operator of the unit shall be liable for its function if it has been incorrectly maintained or repaired by persons who are not employed by the Ewellix Service Department or if the unit has not been operated in accordance with the specified application.

Ewellix shall not be liable for any damage resulting from failure to observe these instructions. These instructions shall not be regarded as an extension of the warranty and liability terms set out in the Conditions of Sale and Supply applied by Ewellix.

The product is not subject to the labelling requirements of the CE or EMC guidelines.

The required EMC measures for the end product must be met by its manufacturer, taking into account installation factors, wiring and control, and these must be checked for compliance with the intended application.

Observance of these instructions is the responsibility of the manufacturer of the machine or equipment.

6.5 Troubleshooting

DANGER

Before performing any adjustments to the mechanisms, the power supply to the actuators must be disconnected.

Risk of electric shock!

Fault	Cause	Remedy
Actuator(s) not working	Control unit not plugged in	Plug in the mains cable.
	Poor connector contact	Plug in the power, control device or motor plug correctly
	Actuator faulty	Return the actuator to the Ewellix Service Department
	Control device faulty	Replace the control device
	Control unit faulty	Replace the control unit
	Actuator overheated	Wait 20 minutes
	Actuator not plugged in	Plug in the motor cable
Markedly reduced speed	Motor, gears or nuts faulty	Return the actuator immediately to the Ewellix Service Department
Very loud running noise	Motor, gears or nuts faulty	Return the actuator immediately to the Ewellix Service Department
Actuator only runs in one direction	Cut-off fault	Return the actuator to the Ewellix Service Department
	Control device faulty	Replace the control device
	Control unit faulty	Replace the control unit
Control unit not working	Control unit not plugged in	Plug the mains cable in
	Control unit faulty	Return the control unit to the Ewellix Service Department
	Mains cable faulty	Return the control unit to the Ewellix Service Department
	Control device faulty	Replace the control device
	Poor connector contact	Fit the plug correctly.
Control device not working	Poor connector contact	Fit the plug correctly

If you are unable to eliminate a fault, contact the Ewellix Service Department.

7.0 Appendix

Technical data

Please refer to the following document:

Ecomag datasheet

PUB IL-07004-EN-October 2019

For further technical information please contact Ewellix

Ecomag

Linear actuator

Benefits

- Compact
- Cost effective
- Silent operation
- Control unit can be mounted to the actuator



Technical data

	Unit	ECO 20/40	ECO 60/80	ECO 30/50	ECO 70/90
Rated push load	N	2 000	6 000	2 000	6 000
Rated pull load	N	0	0	2 000	4 000
Speed (full load to no load)	mm/s	9 to 13	4 to 7	9 to 13	4 to 7
Stroke	mm	50 to 300	50 to 300	50 to 300	50 to 300
Retracted length	mm	S+160	S+160	S+160	S+160
Voltage	V DC	24	24	24	24
Power consumption	W	70	120	70	120
Current consumption	A	4	6	4	6
Duty cycle	%	10 (1/9)	10 (1/9)	10 (1/9)	10 (1/9)
Ambient temperature	°C	+10 to +40	+10 to +40	+10 to +40	+10 to +40
Type of protection	IP	×4S	×4S	×4S	×4S
Weight	kg	2,1	2,1	2,5	2,5
Color	–	Black or grey	Black or grey	Black or grey	Black or grey

Dimensional drawing

Ecomag 2-3-6-7

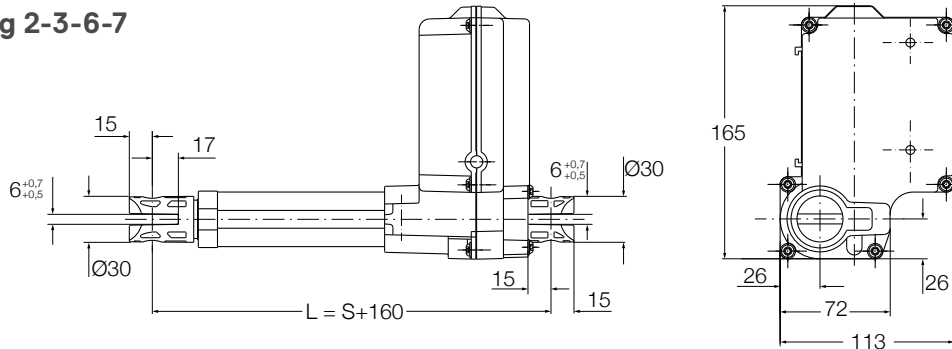

Ecomag 4 -5-8-9

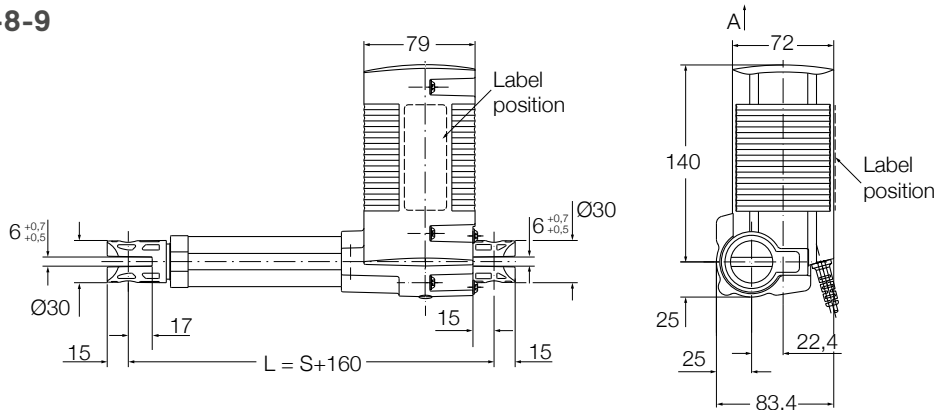

Front attachment push and pull version

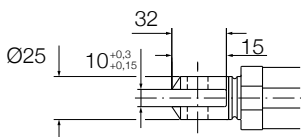

Rear attachment push and pull version

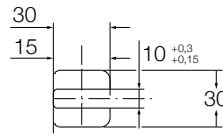

Rear attachment position

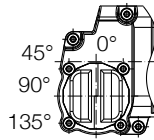

Push version only

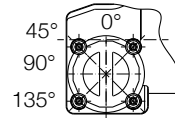

Push and pull version

Legend:

S = stroke

L = retracted length

Connecting diagrams

Jack Plug 24 V DC

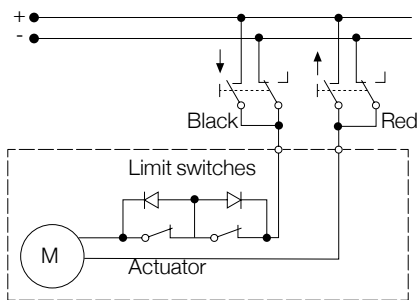

Suitable control units and accessories

ECOMAG	Control units				
	SCU	VCU	BCU	MCU	SEM
Operating switches					
EHA 1	●	●	●	●	●
EHA 3	●	●	●	●	●
EHE	●	●	●	●	●
STJ	●	●	●	●	●
STF	●	●	●	●	●
STA	●	●	●	●	●
STE	●	●	●	●	●

Hand switch

Foot switch

Desk switch

Performance diagrams

Speed-load diagram

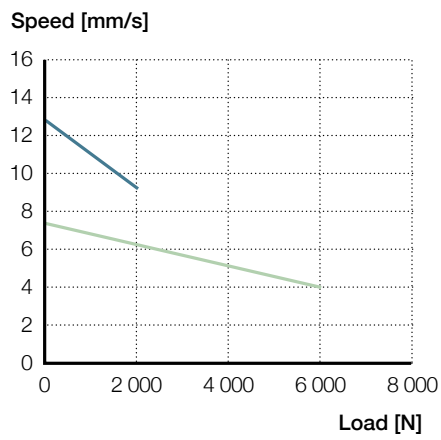

Current-load diagram

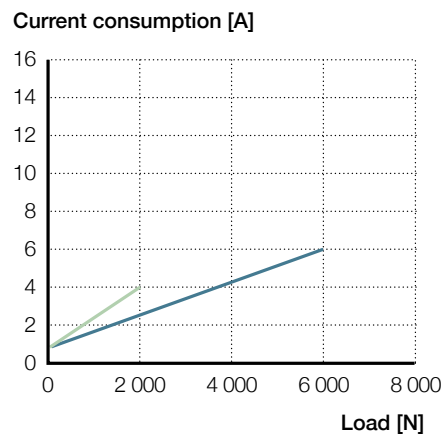

— ECO 20 / 30 / 40 / 50 — ECO 60 / 70 / 80 / 90

Safety factor load conditions

Push load reduction safety factor = 4

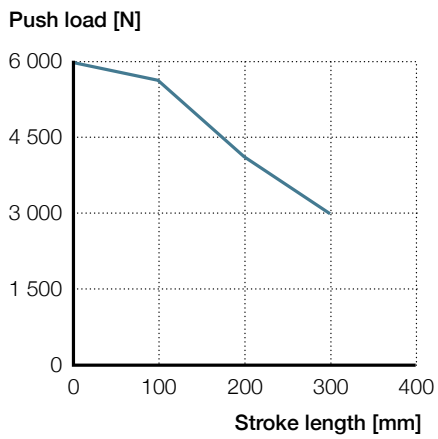

Ordering key

			E	C	O	-									
Type															
Load /Housing															
Push	Pull	Housing													
2 000 N	0 N	Large	2												
2 000 N	2 000 N	Large	3												
2 000 N	0 N	Small	4												
2 000 N	2 000 N	Small	5												
6 000 N	0 N	Large	6												
6 000 N	4 000 N	Large	7												
6 000 N	0 N	Small	8												
6 000 N	4 000 N	Small	9												
Encoder															
No encoder, coiled cable, 2-pin Minifit plug or customization													0		
No encoder, coiled cable, DIN8 plug or customization													9		
2-Hall encoder, 8 pulses, straight cable, DIN8 plug (small housing only)													F		
Current cut-off															
No													0		
Yes (not available for ECO4.-/ECO5.-/ECO8.-/ECO9.-)													1		
Stroke (S)															
50 mm													05		
100 mm													10		
150 mm													15		
200 mm													20		
250 mm													25		
300 mm													30		
Other stroke lengths; 50<S<300 mm													00		
Front attachment (groove depth 17 mm)															
Hole, Ø = 12 mm, groove width 10 mm													M		
Customized													X		
Rear attachment (groove depth 15 mm)															
Hole, Ø = 12 mm, groove width 10 mm													M		
Customized													X		
Orientation of rear attachment															
0°													1		
45°													3		
90°													5		
135°													7		
Color															
Black													A		
Grey													B		
Option															
No option													0		
Back-up nut (available only for drives with 6 kN, mandatory for IEC 60601-1) – only for ECO 7/9, L = +23 mm													A		
Customization															

Options shown in yellow are only available on request. Contact Ewelix for more information on minimum quantities and additional costs.



ewellix.com

© Ewellix

All contents of this publication are the property of Ewellix, and may not be reproduced or given to third parties (even extracts) without permission. Although great care has been taken in the production of this catalog, Ewellix does not take any responsibility for damage or other loss resulting from omissions or typographical errors. The photo may differ slightly in appearance from the actual product. Due to continuous improvements being made in our products, the product's appearance and specifications are subject to change without notice.